

SINGER
600W1

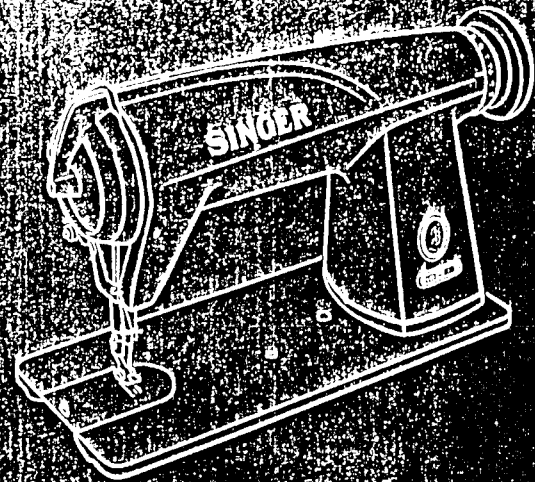

How to get the most
out of your new...

SINGER

600w1

HIGH-SPEED LOCKSTITCH MACHINE

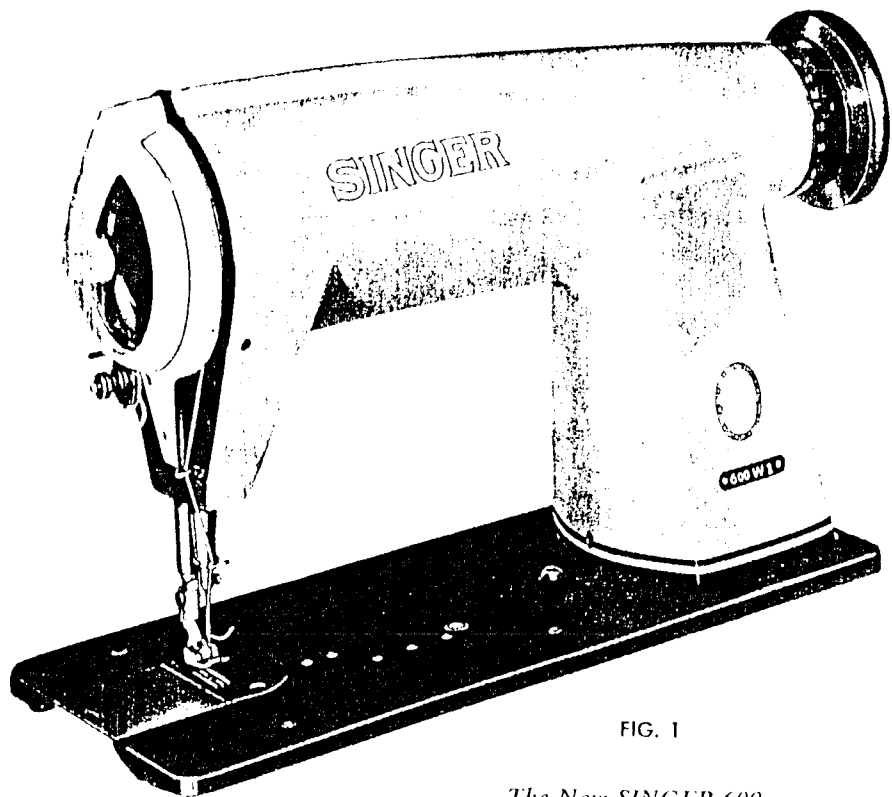
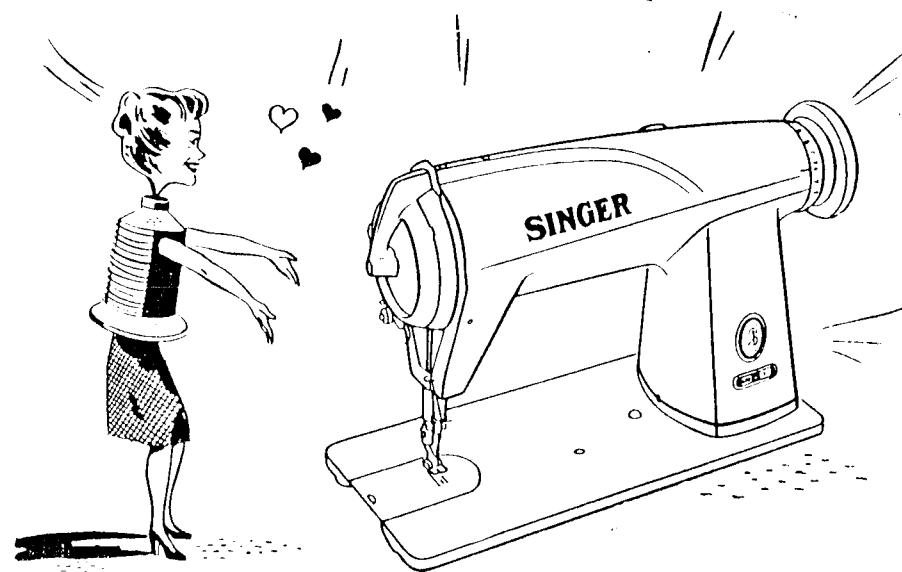

FIG. 1

The New SINGER 600w



Meet your new machine!

You're about to use one of the most dependable, lightest-running machines of its kind. It's designed to give you top quality single-needle lockstitching in light or medium weight fabrics—at the speeds you want—with the ease of handling you like. It starts fast and keeps moving fast—up to 5000 stitches per minute! Its modern styling—in pleasing gray and black color combination—and quiet, smooth operation were planned to make things easier, more pleasant and more comfortable for you. In addition, it has been provided with a thread cutting device that keeps thread from winding on the take-up—easier knee lifter action—easy-to-reach oil points (you don't have to tilt back the head)—and a safety V-belt hand wheel. We think you'll find your new 600w a pleasure to run—and see how much fresher you feel at the end of the day!



Before you do anything else

OIL YOUR MACHINE! Fill the oil reservoir through the oil gauge hole to the top mark on the oil gauge (A, Fig. 2). Also place a few drops of oil in each of the five oil holes (marked in red on machine; points B, C, D, E and F, Fig. 2). **FOR BEST RESULTS,** use SINGER Type A or Type C oil.

Your new 600w is fast

You have a lot of speed and production power at your command — your new 600w will run at speeds up to 5000 stitches per minute — but don't run it at top speed for the first 5 minutes or so the first time you use it. Try to keep it at about half speed during this period to give the oil time to reach the moving parts.

At the beginning of each working day

Check the oil level on the oil gauge and, if necessary, fill to the high mark. *Never allow the oil level to drop below the low mark on the gauge!* Also place a few drops of oil in each of the 5 oil holes shown on Fig. 2. Every few weeks it is desirable that a drop of oil be added to the bobbin winder spindle (see Fig. 5).

Oil Gauge and Oiling Points

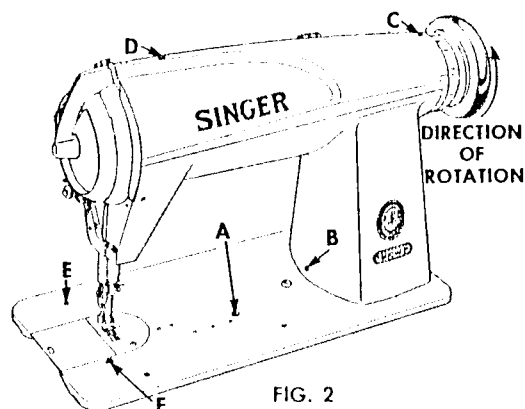

FIG. 2

What to know about needles

As you know, needles can make a big difference in the ease and quality of your work. That's why it's so important that they be just right for the machine and thread you're using. Your floor lady or mechanic knows that your new 600w will give best sewing results when SINGER 88 x 1 are used and they will order and supply you with these needles. Whether you use size 7 or any size up to 21, in either nickel or chrome finish, the correct size will permit the thread to pass freely through the eye of the needle and avoid strain and breaking.

A bent needle will cause your machine to skip stitches, you will be unable to keep a perfectly even margin and, in many cases, a run-off will take place. A hook or burr on the needle point will result in a finish that looks blurred and when short stitches are used (20 to 22 per inch) some materials will even be cut. It's a good idea to check needles often to make sure that these defects aren't present.

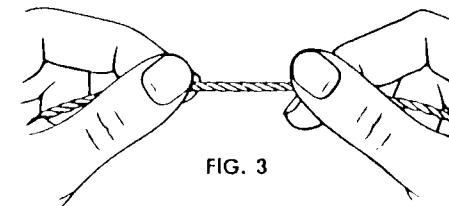

FIG. 3

Determining Thread Twist

—And about thread

In the 600w—as in any lockstitch machine—it is well to use only *left* twist thread in the needle. Either right or left twist thread can be used in the bobbin. To find out the thread twist, hold the thread between the thumb and first finger of each hand as shown in the drawing above. Then roll the thread between the thumb and first finger of the right hand toward you—if the strands of the thread wind tighter, it's left twist; if the strands loosen up or separate, it's right twist.

HERE'S HOW TO . . .

Take out the bobbin

Turn the machine pulley away from you until the needle has been moved to its highest position. Draw back the slide in the bed of the machine. Then reach under the machine and open the bobbin case latch (A, Fig. 4). Grasp the latch and draw the bobbin case out of its place in the sewing hook. While the latch is in its open position the bobbin will be held in the bobbin case. To get the bobbin out, release the latch, turn the open end of the bobbin case down over the table and the bobbin will drop out.

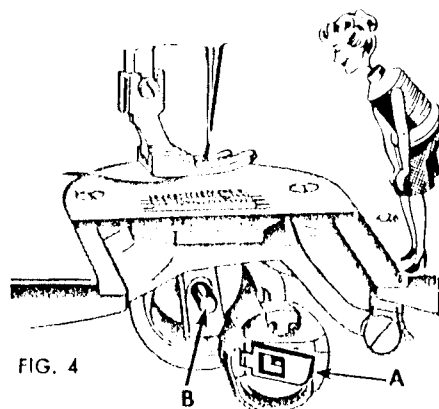

FIG. 4

Removing the Bobbin

Wind the bobbin

Place the bobbin on the bobbin winder spindle (B, Fig. 5) and push it on as far as it will go. Now pass the thread through the thread guide, 1, in the tension bracket and around the back of and between the tension discs, 2. (When winding a fine thread, use a light tension. Tension can be adjusted by turning the nut, C.) Then wind the thread around the bobbin a few times in the direction of the arrow. Push the bobbin winder pulley over against the machine belt and start the machine.

If the thread does not wind evenly on the bobbin, loosen the screw, D, and move the tension bracket to the right or left as necessary. Retighten the screw, D. The amount of thread wound on the bobbin is determined by the screw, E. To wind more thread, turn the screw in; for less

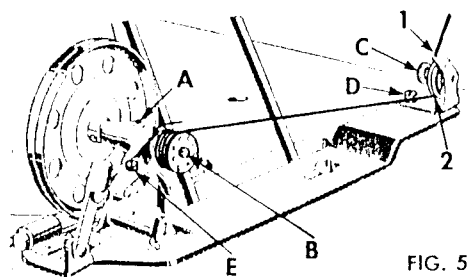

FIG. 5

Winding the Bobbin

thread, turn the screw out. When enough thread has been wound on the bobbin, the winder will stop automatically. Bobbins can be wound while the machine is stitching.

Thread the bobbin case

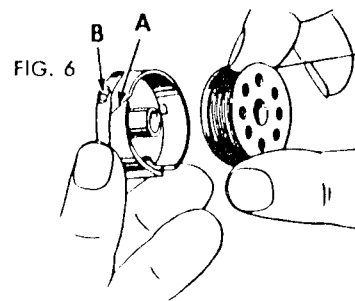

FIG. 6

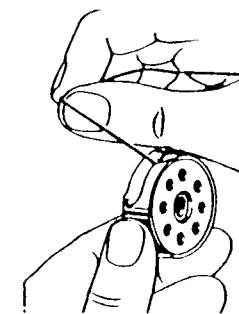

FIG. 7

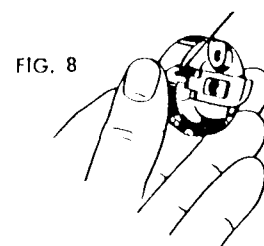

FIG. 8

Hold the bobbin between the thumb and first finger of the right hand so that the thread end comes from the top of the bobbin and out to the right as shown in Fig. 6. Hold the bobbin case in the left hand as shown in the same figure, with the slot (A, Fig. 6) near the top.

Place the bobbin in the bobbin case and pull the thread into the slot (Fig. 7). Then draw the thread under the lip at the end of the tension spring (Fig. 8). Allow about two inches of thread to hang free.

Replace the bobbin case

After threading, hold the bobbin case by the latch and place the case on the center stud (B, Fig. 4) of the bobbin case holder. Release the latch and press the bobbin case back until the latch clicks into place. When properly threaded and replaced, the bobbin case will look as shown in Fig. 9. Close the slide in the bed of the machine.

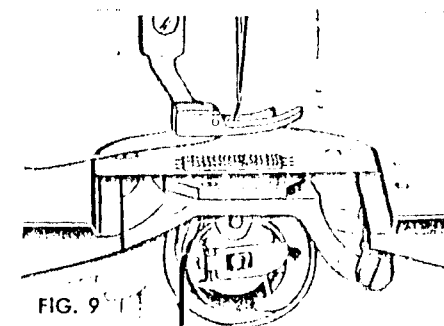

FIG. 9

Bobbin Case Threaded and Replaced

Set the needle

Turn the machine pulley over away from you until the needle bar moves up to its highest point. Loosen the screw at the lower end of the needle bar and move the needle up into the bar or clamp as far as it will go, with the long groove of the needle toward the left and the eye of the needle directly in line with the arm of the machine. Retighten the screw.

It's wise to clean out the needle bar cleanout hole now and then by pushing a needle shank through it. This removes lint and other waste which could keep the needle from seating properly.

Thread the machine

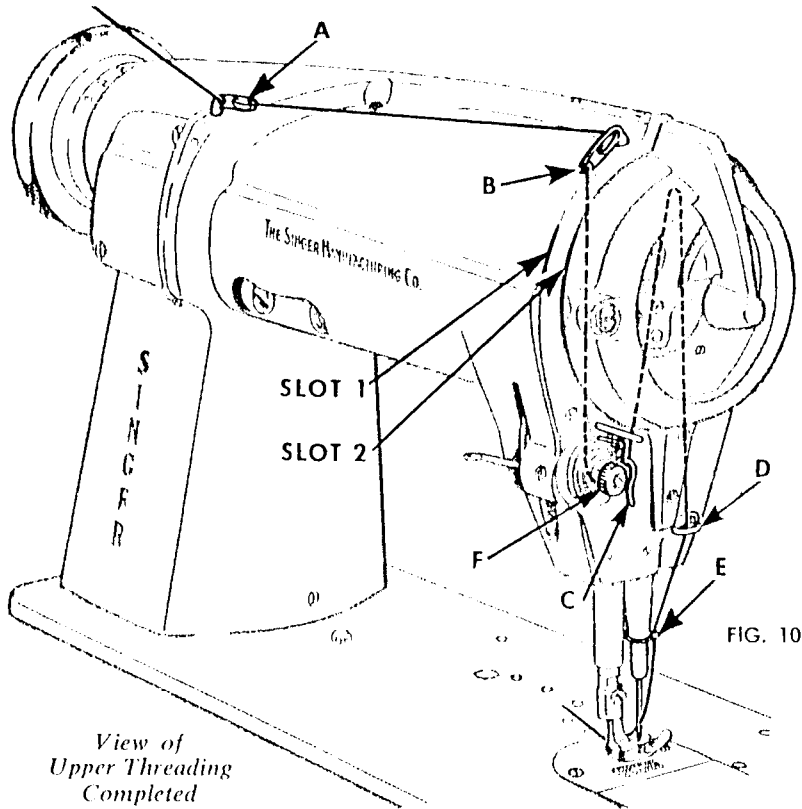

You'll find it's easy to thread the machine once you've become used to it. Pass the thread through the thread retainers A and B in the manner shown in Figure 10. Then hold the thread with the right hand

near thread retainer B and, with the left hand, pass the thread downward into the inner slot 1 and on down around and between the tension discs into the take-up spring and under the thread pull-off C. Then put the thread in slot 2, allowing it to fall in place over the take-up disc as shown in Figure 10. Now release the thread with the right hand and continue to pass it down through the two thread guides, D and E, and then from left to right through the eye of the needle. Leave about three inches of thread with which to begin sewing.

Get set

Hold the end of the needle thread with the left hand, leaving the thread slack from the hand to the needle. Then turn the machine pulley over away from you slowly until the needle moves down and up again to its highest point. Pull on the needle thread and the bobbin thread will come up through the hole in the throat plate (as shown in Fig. 11). Push both threads back away from you and under the presser foot.

Drawing Up the Bobbin Thread

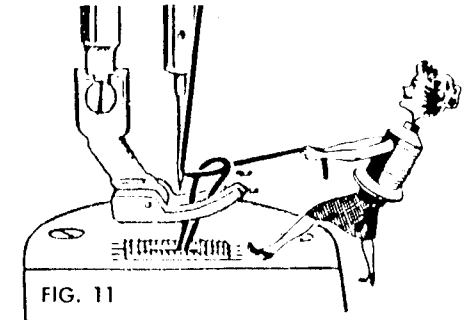

FIG. 11

Go

You're now ready to sew—quickly, smoothly, easily. Just place the material under the presser foot, lower the foot—and go!

If this happens

If the thread breaks at operating speeds, be sure to examine the thread take-up, which can be seen through the take-up cover (A, Fig. 12), for any thread which may have broken off. Slide open the cover (watch out for the thread cutter, B!) and remove the broken thread before rethreading. If you can't see a broken end of thread around the take-up, just rethread the machine and sew.

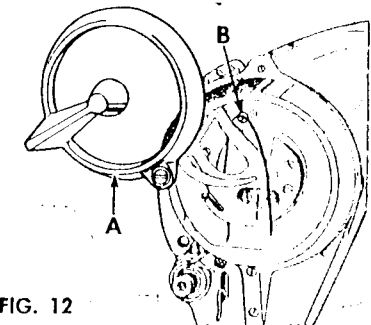

FIG. 12

To Remove Broken Thread from Take-Up

To remove the work

Stop the machine when the needle bar has just started to come down because in this position the upper thread will be free of the sewing hook and the take-up will not pull the thread out of the needle when the machine is started again. Raise the presser foot, draw the work back behind the presser foot and cut the threads close to the work.

Watch your tensions

RIGHT

Normally—and probably for all the sewing you will do—tension on the needle and bobbin thread should be balanced so that if you were to cut straight down through the center of a line of stitching and then look at it from the side it would look like this, with the needle and bobbin threads locked in the center of the thickness of the material:

FIG. 13



Perfect Stitch

WRONG

If there's too much tension on the needle thread or not enough on the bobbin thread, the needle thread will not be pulled down into the material and a poor stitch will result with the needle thread riding the top of the material like this:

FIG. 14



Too Tight Needle Thread Tension

WRONG

If there's too much tension on the bobbin thread and not enough on the needle thread, you'll get the reverse of the condition shown in Fig. 14 but the stitch is just as poor. The thread will ride the bottom of the material like this:

FIG. 15



Too Loose Needle Thread Tension

What to do about tensions

Needle Thread—First, regulate the needle thread tension *only when the presser foot is down!* To increase the tension, turn in the small thumb nut (F, Fig. 10) on the tension discs over toward you. To reduce the tension, turn the thumb nut away from you.

Bobbin Thread—Once the tension on the bobbin thread has been properly adjusted, it is seldom necessary to change it because the proper stitch can usually be obtained by adjusting the tension on the needle thread. Tension on the bobbin thread is adjusted by the screw B, Fig. 6, in the tension spring on the outside of the bobbin case. To increase tension, turn this screw to the right. To reduce tension, turn this screw to the left.

To adjust presser foot pressure

Correct presser foot pressure helps feed the work properly. You can adjust it by means of the screw A, Fig. 16, in the top of the arm. To increase the pressure, turn this screw in (clockwise). To reduce the pressure, turn this screw out (counterclockwise). Your pressure is correct when the work moves steadily and smoothly without "stalling."

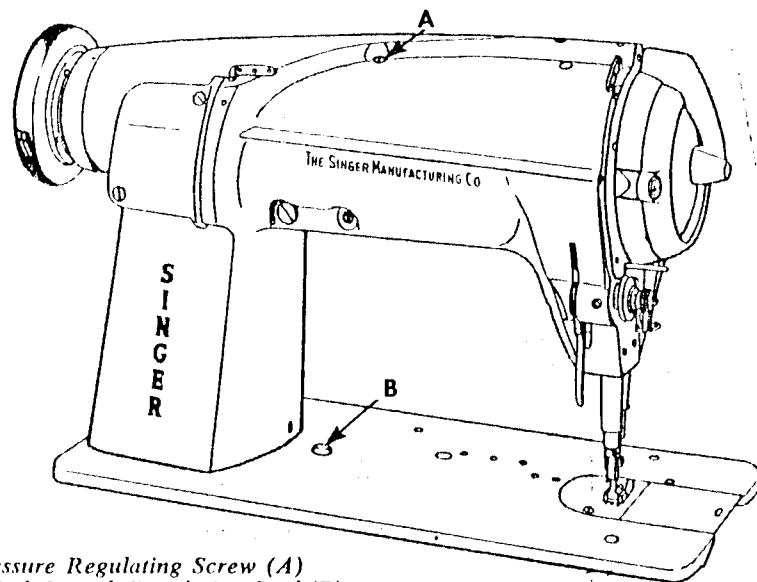

FIG. 16

Pressure Regulating Screw (A)
and Stitch Length Regulating Stud (B)

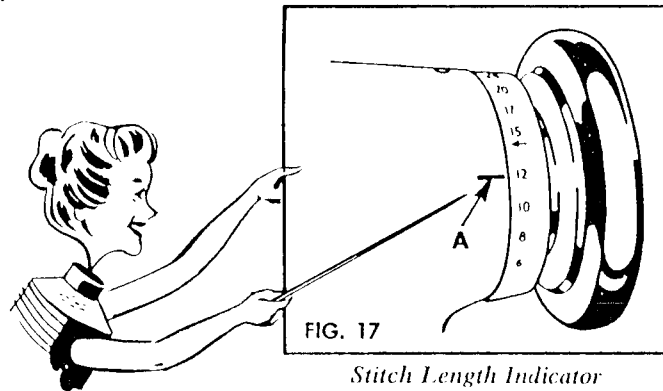

FIG. 17
Stitch Length Indicator

When you want to change the stitch length

It's easy—just hold down the stud B, Fig. 16, in the bed of the machine and turn the machine pulley slowly over away from you . . . until the stud enters the notch in the eccentric (you'll hear the click). Then, still holding the stud, turn the machine pulley until the number indicating the number of stitches per inch you want is opposite the mark A, Fig. 17. Then release the stud. A setting of 12 stitches per inch is shown in this illustration although you can set the machine to make as few as $5\frac{1}{2}$ stitches to the inch or as many as 30. *Be careful not to press this stud while the machine is running!*

Dos and Don'ts

DOs

- ✓ Oil your new 600w regularly.
- ✓ When turning the machine pulley *always* turn it away from you.
- ✓ Always keep the bed slide *closed* when the machine is in operation.
- ✓ Clean out any build-up of lint or other waste around the hook and between the feed rows on the under side of the throat plate.
- ✓ Always be sure the take-up cover is closed before you run the machine.

DON'Ts

- ✗ Don't run the machine with the bobbin case only partly inserted.
- ✗ Don't try to "help" the machine by pulling the fabric. If the machine is operating properly it will do all the work itself. Pulling the fabric may bend or break the needle.
- ✗ Don't press on the knee lifter while the machine is running.
- ✗ Don't ever touch the stitch regulator button while the machine is running.
- ✗ Don't run the machine when it's threaded unless there is material under the presser foot.

Why it's important to use
only SINGER parts and needles
in SINGER machines

As you know, *any* machine—from a washing machine to an automobile—will operate better and more dependably when you use accessories, fittings or replacement parts made by the original manufacturer. This is true—and perhaps even more true—in the case of SINGER machines. That's why you should always make sure that you get SINGER parts and that all needles and their containers are marked with this SINGER trademark:

"SIMANCO"

Needles in containers marked "For Singer Machines" are NOT made by SINGER.

